

CFP16W

COMPACTORS

OPERATING INSTRUCTIONS

Translation of the original Instructions



NORTON
SAINT-GOBAIN®

clipper®



CE Declaration of conformity

The undersigned manufacturer: **SAINT - GOBAIN ABRASIVES S.A.**
190, BD. J. F. KENNEDY
L-4930 BASCHARAGE

Declares that this product: Norton Clipper Compactors **CFP16 W**
Code: **70184608011 Honda GX 160**

Is in conformity with the following Directives:

"MACHINES" 2006/42/CE
"NOISE" 2000/14/CE

And European standard :

- **EN 500-1** Mobile road construction machinery. Safety - Part 1: Common requirements
- **En 500-4** Mobile road construction machinery - Safety - Part 4: Specific requirements for compaction machines

Valid for machines as of serial number : 450xxxxxxx

Storage site for the technical documents :

Saint-Gobain Abrasives 190, Bd. J. F. Kennedy 4930 BASCHARAGE, LUXEMBOURG

This declaration of conformity loses its validity when the product is converted or modified without agreement.

Bascharage, Luxembourg, le 01.09.2019 :



François Chianese, executive officer.



Declaration of conformity

The undersigned manufacturer:

SAINT - GOBAIN ABRASIVES S.A.
190, BD J.F. KENNEDY
L- 4930 BASCHARAGE

Declares that this product:

Compactor **CFP 16 W Honda GX 160**

Code: **70184608011**

is in conformity with the following standard:

- ***Supply of Machinery (Safety) Regulations 2008***
- ***Noise Emission in the Environment by Equipment for use Outdoors Regulations 2001***

And European standard :

- ***EN 500-1*** Mobile road construction machinery. Safety - Part 1: Common requirements
- ***EN 500-4*** Mobile road construction machinery - Safety - Part 4: Specific requirements for compaction machines

Valid for machines with a serial number greater than: 450xxxxxxx

Authorised Representative:

SAINT-GOBAIN ABRASIVES

Unicorn House • Unit 1, Amison Close

Redhill Business Park • Stafford • England • ST16 1WB

This declaration of conformity loses its validity when the product is converted or modified without agreement.

Bascharage, Luxembourg, 22.06.2022

François Chianese, executive officer.

Norton Clipper CFP16W

OPERATING INSTRUCTIONS

TABLE OF CONTENTS

1-BASIC SAFETY INSTRUCTIONS	5
<i>1.1 Symbols</i>	<i>5</i>
<i>1.2 Machine plate</i>	<i>6</i>
<i>1.3 Safety instructions for particular operating phases</i>	<i>6</i>
2-MACHINE DESCRIPTION	7
<i>2.1 Short description</i>	<i>7</i>
<i>2.2 Purpose of use</i>	<i>7</i>
<i>2.3 Layout</i>	<i>8</i>
<i>2.4 Technical DATA</i>	<i>9</i>
2.5 VIBRATION MEASUREMENTS	9
2.6 SOUND MEASUREMENTS	9
3-ASSEMBLY AND COMMISSIONING	10
<i>3.1 Handle</i>	<i>10</i>
<i>3.2 Starting the machine</i>	<i>10</i>
4-Transport and storing	11
<i>4.1 Securing for transport</i>	<i>11</i>
<i>4.2 Transport procedure</i>	<i>11</i>
<i>4.3 Long period of inactivity</i>	<i>11</i>
5- OPERATING THE MACHINE	11
<i>5.1 Site of work</i>	<i>11</i>
<i>5.2 Preparing the site</i>	<i>11</i>
6- MAINTENANCE AND SERVICE	12
<i>6.1 Maintenance of the machine</i>	<i>12</i>
7- FAULT: CAUSES AND CURES	12
<i>7.1 Fault –finding procedures</i>	<i>12</i>
<i>7.2 Troubles-shooting guide</i>	<i>13</i>
<i>7.3 Spare parts</i>	<i>14</i>

1-BASIC SAFETY INSTRUCTIONS

The Norton Clipper CFP16W is exclusively designed for compaction mainly on construction sites. Uses other than the manufacturer's instructions shall be considered as contravening the regulations. The manufacturer shall not be held responsible for any resulting damage. Any risk shall be borne entirely by the user. Observing the operating instructions and compliance with inspection and servicing requirements shall also be considered as included under use in accordance with the regulations.

1.1 Symbols

Important warnings and pieces of advice are indicated on the machine using symbols. The following symbols are used on the machine:



Read operator's instructions



Ear protection must be worn



Hand protection must be worn



Eye protection shall be worn



For dry cutting in exceptional cases, wear additional dust



Shoes protection must be worn



Use only the integrated crane hook if you lift up

1.2 Machine plate

Important data can be found on the following plate located on the machine:

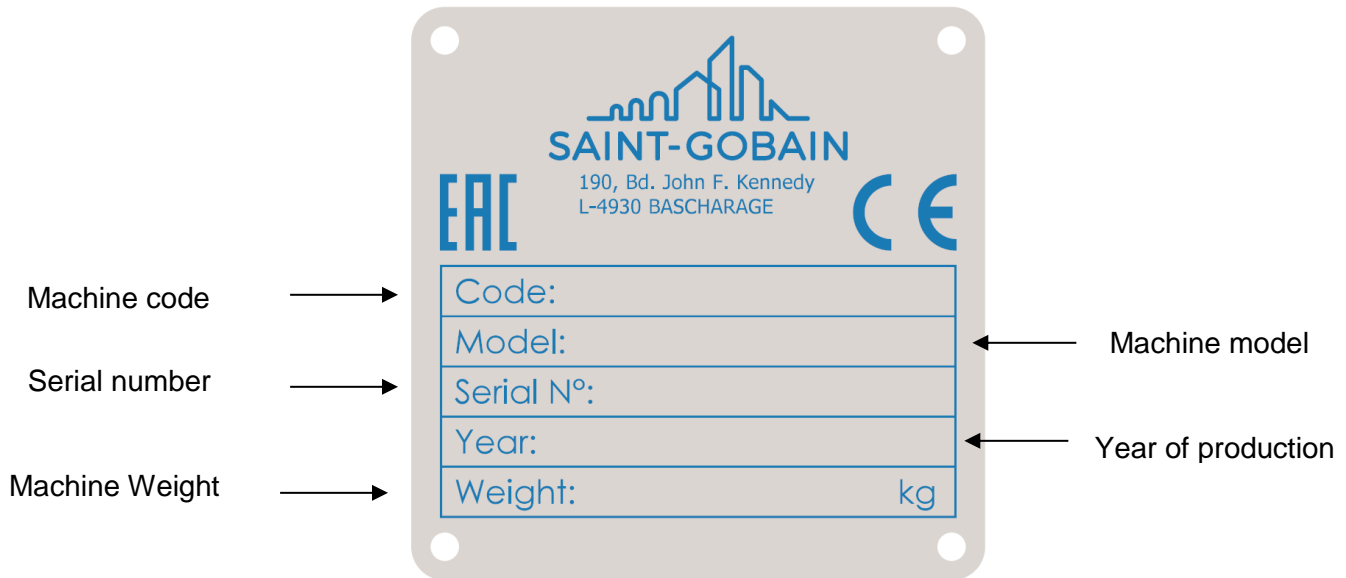

1.3 Safety instructions for particular operating phases

Before starting the work

- Before commencing work, make yourself familiar with the working environment at the place of use. The working environment includes: obstacles in the area of work and manoeuvre, the firmness of the floor, necessary protection at the site relating to public thoroughfares and the availability of help in the event of accidents..
- Plate compactors must only be used for compaction jobs observing safety and operating instructions.
- People who work with plate compactors must know everything regarding safety instructions.
- Do not take drugs or drink alcohol before using plate compactors.
- Always wear appropriate protective clothes (ear protections, gloves, protecting shoes and helmet).
- Do not alterate the operation devices of the plate compactor.
- Do not leave control elements during compaction.
- Store the compactor with engine off in a safe place.
- Always refill fuel tank when the engine is off. Do not allow fuel to come into contact with the hot parts of compactor and engine.
- Do not smoke when using compactor. Keep the compactor out of open flames.
- Always check fuel tank cap. If there is a fuel cock, shut it off when the engine is not working.
- Do not use the compactor in places where there are gaseous exhalations.
- Do not use the machine indoors or in an enclosed area unless inadequate ventilation.
- Always wear appropriate protective clothes.
- When the work area is near slopes, the compactor could turn over.
- When you use compactor in reverse and in a narrow place, the operator must be sideways from the handle in order to avoid stumbling.
- Always operate in safe conditions in order to avoid accidents.
- Always operate in maximum stability conditions.

- Use transport wheels only for movements in yard. In all the other situations they must be removed.
- Always make sure of the proper functioning of the safety and control devices.
- If there are any problems, stop immediately the machine and inform the person responsible of the yard.
- Attention is drawn to the use of BS2092 safety goggles in conformity with specified Processes No.8 of the Protection of Eyes Regulation 1974, Regulation 2(2) Part 1. and additional dusk mask for dry cutting (only in exceptionally cases).

CLIMBING ABILITY

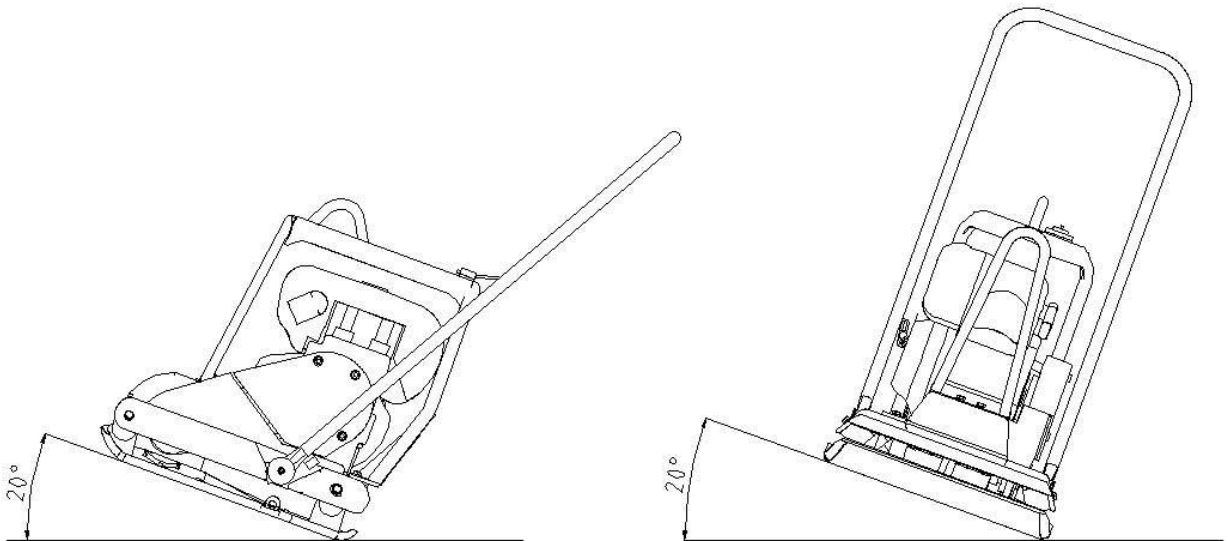

2-MACHINE DESCRIPTION

Any modification, which could lead to a change in the original characteristics of the machine, may be done only by Saint-Gobain Abrasives who shall confirm that the machine is still in conformity with the safety regulations.

2.1 Short description

The compactor CFP16W is suitable for repairing asphalted surfaces, for small compacting jobs and for preparing green areas

As with all other NORTON products, the operator will immediately appreciate the attention given to detail and quality of materials used in construction. The machine and its component parts are assembled to high standards assuring long life and minimum maintenance.

2.2 Purpose of use

The vibration required for tamping is produced by the exciter which is on the compacting plate.

The engine starts the exciter and the torque is transmitted by the centrifugal clutch and by the belt.

In order to allow the idling of the drive engine, the centrifugal clutch, at low engine speeds, interrupts the flow of power to exciter. The compactor must always be used with the gas handle in the "OPERATIVE" position.

The engine supporting and the compacting plates are connected by 4 shockmount, which are mounted to avoid that vibrations reach the operator.

Only use the machine for the purpose for which it is intended.

2.3 Layout

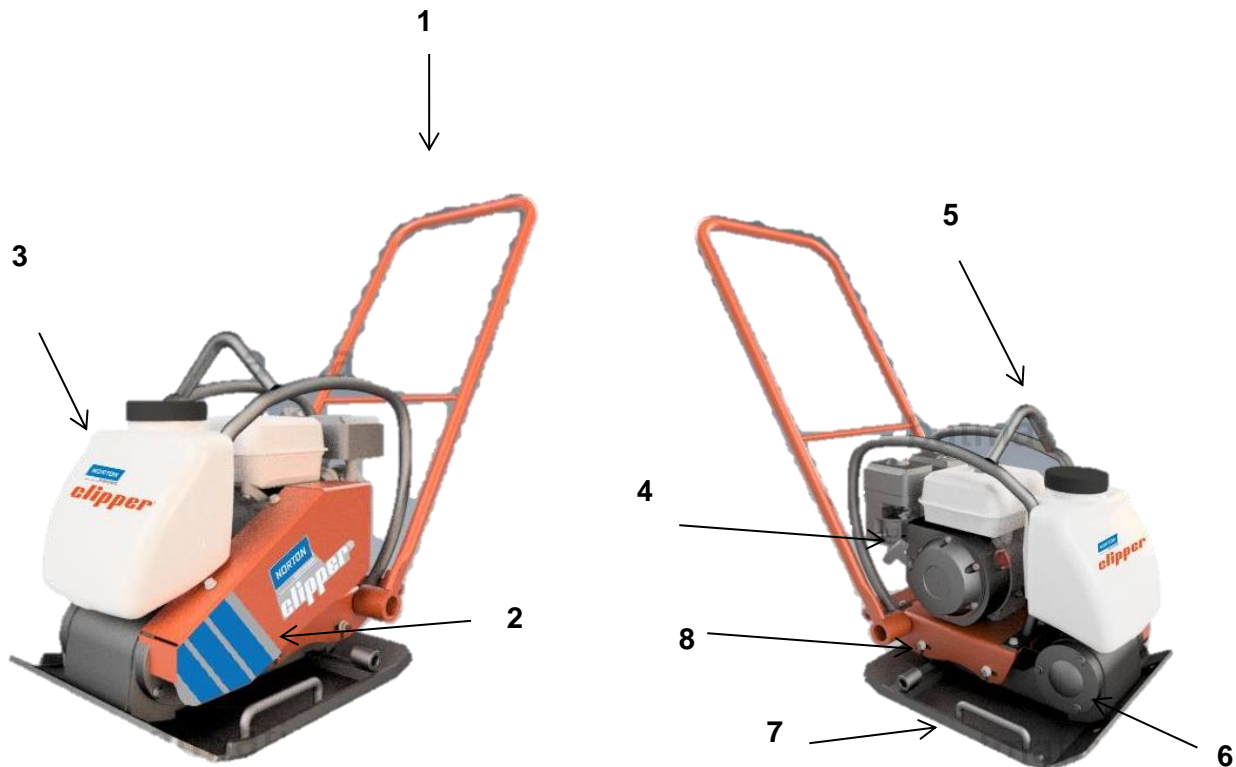

Handle (1)

Jig welded steel construction is connected by 4 shockmount on the frame of the machine to reduce the vibrations reach the operator

Belt drive and belt cover (2)

A centrifugal clutch inside the engine pulley drives the gear shaft through V-Belts. It allows to gradually engaging the vibration of the machine. The drive assembly is enclosed in a metal guard.

Water tank (3)

Resistant plastic water tank

Thermal Engine (4)

The machine has a GX160 Honda engine with 4,8HP (3.6kw)

Lifting eye (5)

To lift the machine easily and safely, a lifting eye is located over the engine. This allows a balanced lifting of the machine.

Eccentric element (6)

In the our compactors the system of eccentric elements has been optimized by moving the weight to the right side of the axle, so that less weight counteracts the movement at start-up.

Less power is required to initiate the vibratory action, reducing energy consumption at start-up by 50% and thus using less fuel.

Plate (7)

The plates have rounded edges and raised to avoid marking the surface

Shock absorbers (8)

The engine supporting and the compacting plates are connected by 4 shockmount, which are mounted to avoid that vibrations reach the operator.

2.4 Technical DATA

Model	CFP16 W
Dimensions plate	500 x 560 mm
Width x Length	
Operating weight	91 kg
Working speed	25 m/min
Max climbing ability	20%
Frequency	90 Hz
Centrifugal force	16 kN
Transmission	Centrifugal clutch / belt
Engine	Air-cooled single-cylinder 4 stroke Honda GX 160
Engine power	kW 3,6 (HP 4,8)
Displacement	163 cm ³
Fuel	Petrol
Fuel consumption	1,4
Fuel tank capacity	3,1 ltrs

2.5 VIBRATION MEASUREMENTS

The engine supporting and the compacting plates are connected by 4 shockmount, which are mounted to avoid that vibrations reach the operator.

Products are tested for hand/arm vibration level in accordance with annex D prEN500-4:2001

The hand/harm vibration level is **2,2** m/s².

The plate compactor has been tested on a surface, produced with not cleaned stone crusher grit, with 16 mm medium diameter (with components which have diameter that goes from 10 to 20 mm).

2.6 SOUND MEASUREMENTS

The product has been produced in accordance with the standard 2000/14/CE, procedure I annex VI.

Measured sound power level **99** [dB(A)] and guaranteed sound power level **103** [dB(A)] on a significant equipment.

3-ASSEMBLY AND COMMISSIONING

3.1 Handle

Set the machine arm in a comfortable position. To that purpose, loosen the handle on the arm and set the arm at the right angle, then retighten the handle.

3.2 Starting the machine

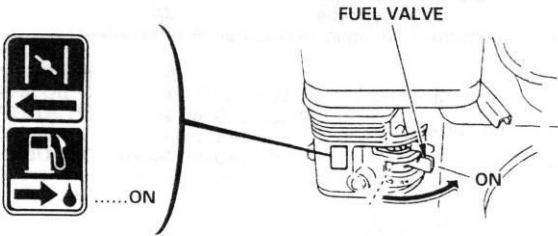
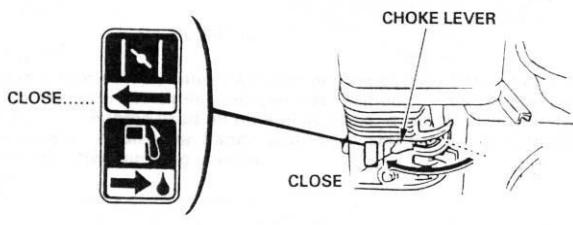
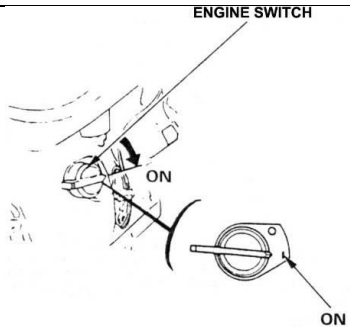
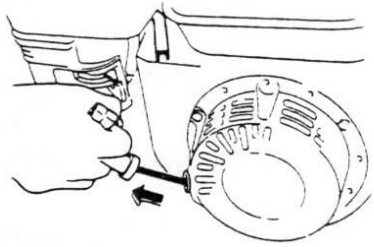
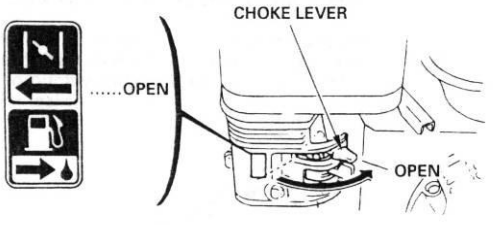
	
<p>Turn the fuel valve to the ON position. Fully press the dead-man handle against the main handle.</p>	<p>Move the choke lever to the CLOSED position. NOTE: do not use the choke if the engine is warm or the air temperature is high.</p>
	
<p>Move the throttle control lever slightly to the left. Put the engine switch on ON.</p>	<p>Pull the starter grip lightly until you feel resistance, then briskly. CAUTION: Do not allow the starter grip to snap back against the engine. Return it gently to prevent damage to the starter.</p>
	
<p>As the engine warms up, gradually move the choke lever to the OPEN position. Position the throttle control lever for the</p>	<p>Maximum engine speed.</p>

To stop the engine, release the dead-man handle, move the throttle control lever fully to the right, then turn the engine switch to the OFF position. Turn the fuel valve to the OFF position.

CAUTION: when the machine is switched off, the tools will continue turning slowly to complete stop. Be therefore very careful to avoid injuries.

4-Transport and storing

4.1 Securing for transport

Conform yourself to work regulations, in order to transport the machine safely. To help you transport the machine, you can remove the transport tube from under the handle and located in the front hole of the machine.

4.2 Transport procedure

Conform yourself to work regulations, in order to transport the machine safely. To help you transport the machine, you can remove the transport tube from under the handle and located in the front hole of the machine.

4.3 Long period of inactivity

If the machine is not going to be used for a long period, completely clean the machine and disassemble the tools. The storage site must be clean, dry and at a constant temperature.

5- OPERATING THE MACHINE

5.1 Site of work

- Remove from the site anything, which might hinder the working procedure!
- Make sure the site is sufficiently well lit!
- Make sure you have a continual adequate view of the working area so you can intervene in the working process at any time!
- Keep other staff out of the area, so you can work securely.

5.2 Preparing the site

Ad equation to compaction, it will be necessary to identify the characteristics of soils and material, to study their ability

6- MAINTENANCE AND SERVICE

6.1 Maintenance of the machine

To ensure a long-term quality from the use of the Clipper compactors CPF16W, please follow the maintenance plan below:

		Daily	After 20h00	Monthly	After 100h00	After 150h00	After 200h00
Air filter	Check filter, clean or replace if necessary						
Oil filter	Check filter oil level (only oil bath models)						
Fuel tank	Check fuel tank and fuel cap lid. If necessary replace.						
Engine	Check oil level, refill if necessary						
Engine	Check engine RPM						
Exciter	Check exciter lid						
Engine	First oil change						
Engine	Clean spark plug						
V-Belt	Check V-belt tension						
Fuel Tank	Check fuel filter, replace if necessary						
Engine	Oil change						
Exciter(bath oil only)	Check oil level, refill if necessary						
Exciter(bath oil only)	Oil change						

7- FAULT: CAUSES AND CURES

7.1 Fault –finding procedures

Should any fault occur during the use of the machine, turn it off. Any works dealing with the engine of the machine can only be carried out by a qualified technician.

7.2 Troubles-shooting guide

TROUBLE	POSSIBLE CAUSE	SOLUTION
The engine works properly but the machine does not vibrate	The transmission belt is broken	Replace the belt
	The wear and tear has caused the belt to loosen up	
	The centrifugal clutch has broken	Replace the centrifugal clutch
Reduced or irregular speed	The engine rpm is not correct	Verify that during compaction gas lever is in "OPERATIVE" position
		Reset the number of engine rpm
	The transmission belt has loosened up	Tension the transmission belt and, if necessary, replace it
The engine rpm are low but the exciter does not stop	Centrifugal clutch malfunction	Repair the centrifugal clutch and, if necessary, replace it
The exciter heats up to over 90° (bath oil only)	There is too much of oil in the exciter	Top up the oil level. Check whether the oil seal has been damaged; if necessary replace it
The engine works with difficulty and the exciter is too noisy and it stops or slows down	Mechanical block of the exciter (bearings, shaft)	Remove the element causing the failure or, if necessary, replace the exciter
The engine turns off or does not work properly	Fuel tank empty	Add fuel
	Oil lack	Add oil
	Dirty air filter	Clean air filter, if necessary replace it
	Engine damaged	Contact an engine service center

7.3 Spare parts

In order to consult the spare parts lists, we invite you to visit the after-sales website of Norton Clipper by using the following address:

<https://spareparts.nortonabrasives.com>

For a quick access, you can also use the QR Code shown below using your mobile phone:



This electronic catalogue provides exploded views and spare parts lists for different machines designed by Norton Clipper so you can find references you need.

When ordering spare parts, please mention:

- The serial number.
- The code of the part.
- The exact denomination.
- The number of parts required.
- The delivery address.
- Please indicate clearly the means of transportation required such as "express" or "by air". Without specific instructions, we will forward the parts through the means which seem appropriate to us - -- but which is not always the quickest way.

Clear instructions will avoid problems and faulty deliveries.

If not sure, please send us the defective part. In the case of a warranty claim, the part must always be returned for evaluation. Spare parts for the motor can be ordered with the manufacturer of the motor or with their dealer, which is often quicker and cheaper.

This machine has been manufactured by Saint-Gobain Abrasives S.A.

190, Bd. J.F. Kennedy
L- 4930 BASCHARAGE
Grand-Duché de Luxembourg.
Tel.: 00352-50401-1

<http://www.construction.norton.eu>

e-mail: sales.nlx@saint-gobain.com

Guarantee can be claimed and technical support obtained from your local distributor where machines, spare parts and consumables can be ordered as well:

SAINT-GOBAIN ABRASIVES
INDUSTRIEWEG 21
9420 ERPE-MERE
BELGIUM
TEL: +32(0) 2 267 21 00

SAINT-GOBAIN ABRASIVES, S.R.O.
POČERNICKÁ 272/96, MALEŠICE
108 00 PRAHA 10
CZECH REPUBLIC
TEL: +420 255 719 326
FAX: +420 255 719 321

SAINT-GOBAIN ABRASIVES A/S
DYBENDALSVEJENGET 2,
DK-2630 TAASTRUP
DENMARK
TEL: +45 4675 5244

PO BOX 643706
FORTUNE TOWER OFFICE 2106
JLT BLOCK C
(NEXT TO METRO STATION)
JUMEIRA LAKE TOWER, DUBAI
UNITED ARAB EMIRATES
TEL: +971 4 431 5154
FAX: +971 4 431 5434

SAINT-GOBAIN ABRASIFS
RUE DE L'AMBASSADEUR - B.P.8
78 702 CONFLANS CEDEX
FRANCE
TEL: +33 (0)1 34 90 40 00
FAX: +33 (0)1 39 19 89 56

SAINT-GOBAIN ABRASIVES GMBH
BIRKENSTRASSE 45-49
D-50389 WESSELING
GERMANY
TEL: +49 (0) 2236 703-1
+49 (0) 2236 8996-0
+49 (0) 2236 8911-0
FAX: +49 (0) 2236 703-367
+49 (0) 2236 8996-10
+49 (0) 2236 8911-30
FÜR DEN FACHHANDEL
ÖSTERREICH
TEL: +43 (00) 662 430 076

SAINT-GOBAIN ABRASIVES KFT.
1225 BUDAPEST
BÁNYALÉG U. 60/B.
HUNGARY
TEL: +36 1 371 22 50
FAX: +36 1 371 22 55

SAINT-GOBAIN ABRASIVI S.P.A
VIA PER CESANO BOSCONI 4
I-20094 CORSICO MILANO
ITALY
TEL: +39 02 44 851
FAX: +39 02 44 78 266

SAINT-GOBAIN ABRASIVES S.A.
190 RUE J.F. KENNEDY
L-4930 BASCHARAGE
GRAND DUCHE DE LUXEMBOURG
TEL: +352 50 401 1
FAX: +331 83 717 792
NO. VERT (FRANCE): 0800 906 903

SAINT-GOBAIN ABRASIFS, S.A.
2 ALLÉE DES FIGUIERS
AIN SEBAË - CASABLANCA
MOROCCO
TEL: +212 5 22 66 57 31
FAX: +212 5 22 35 09 65

SAINT-GOBAIN ABRASIVES BV
GROENLOSEWEG 28
7151 HW EIBERGEN
P.O. BOX 10
7150 AA EIBERGEN
THE NETHERLANDS
TEL: +31 545 466466
FAX: +31 545 474605

SAINT-GOBAIN ABRASIVES AS
POSTBOKS 11, ALNABRU,
0614 OSLO
BROBEKKVEIEN 84,
0582 OSLO
NORWAY
TEL: +47 63 87 06 00
FAX: +47 63 87 06 01

SAINT-GOBAIN HPM POLSKA SP. Z O.O.
UL. NORTON 1, 62-600 KOŁO
62-600 KOŁO
POLAND
TEL: +48 63 26 17 100
FAX: +48 63 27 20 401

SAINT-GOBAIN ABRASIVOS, L. DA
ZONA INDUSTRIAL DA MAIA
I-SECTOR VIII, NO. 122
APARTADO 6050
4476 - 908 MAIA
PORTUGAL
TEL: +351 229 437 940
FAX: +351 229 437 949

SAINT-GOBAIN GLASS
BUSINESS UNIT ABRASIVI
PUNCT DE LUCRU: LOC.VETIS,JUD.
SATU MARE 447355
STR. CAREIULUI 11
PARC INDUSTRIAL RENOVATIO
ROMANIA
TEL: +40 261 839 709
FAX: +40 261 839 710

SG HPM RUS
58, F. ENGELS STR.
STROENIE 2
105082 MOSCOW
RUSSIA
TEL: +74 955 408 355
FAX: +74 959 373 224

SAINT-GOBAIN
ABRASIVES (PTY) LTD
2 MONTEER ROAD
ISANDO 1600
P.O. BOX 67
SOUTH AFRICA
TEL: +27 11 961 2000
FAX: +27 11 961 2184/5

SAINT-GOBAIN ABRASIVOS, S.A.
CTRA. DE GUIPÚZCOA, KM. 7,5
E-31195 BERRIOPLANO (NAVARRA)
SPAIN
TEL: +34 948 306 000
FAX: +34 948 306 042

SAINT GOBAIN ABRASIVES AB
GÅRDSFOGDEVÄGEN 18A
168 66 BROMMA • SVERIGE
SWEDEN
TEL: +46 8 580 881 00
FAX: +46 8 580 881 30

SAINT-GOBAIN INOVATIF MALZEMELER
VE ASINDIRICI SAN. TIC. AS.
ALTAYÇEŞME MAH. ÇAMLI SOK. NO:21
ESAS OFIS PARK KAT:9 34843
MALTEPE, İSTANBUL • TURKEY
TEL: 0090-216-217 12 50
FAX: 0090-216-442 40 74

SAINT-GOBAIN ABRASIVES LTD.
DOXEY RD
STAFFORD
ST16 1EA
UNITED KINGDOM
TEL: +44 1785 222 000
FAX: +44 1785 213 487



Saint-Gobain Abrasifs
190 Rue J.F. Kennedy
L-4930 Bascharage
Grand Duche de Luxembourg
Tel: +352 50 4011
Fax: +331 83 717 792
no. vert (France) 0800 906 903

www.nortonabrasives.com/fr-fr